

Przekrój A-A

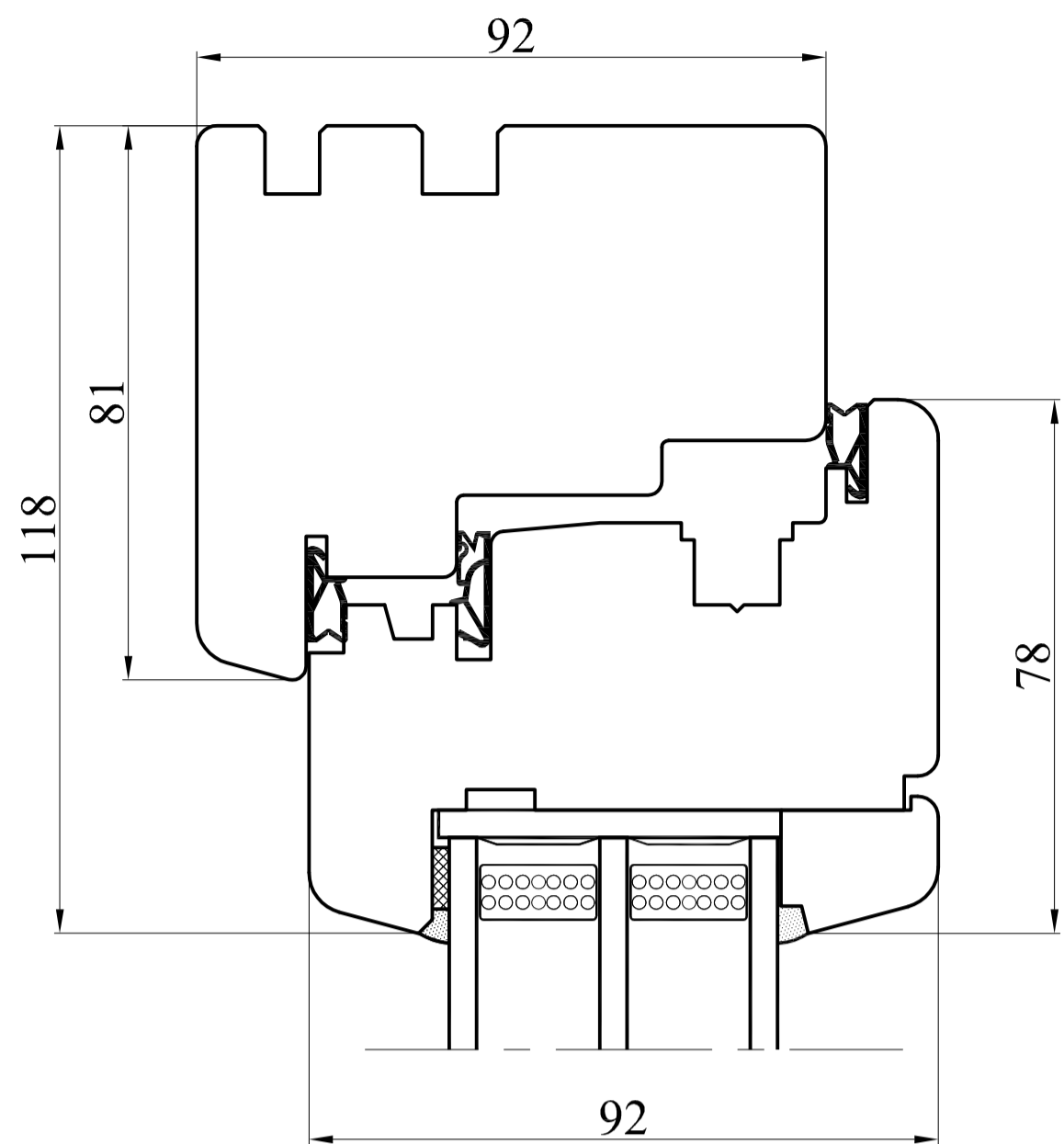

Przekrój B-B

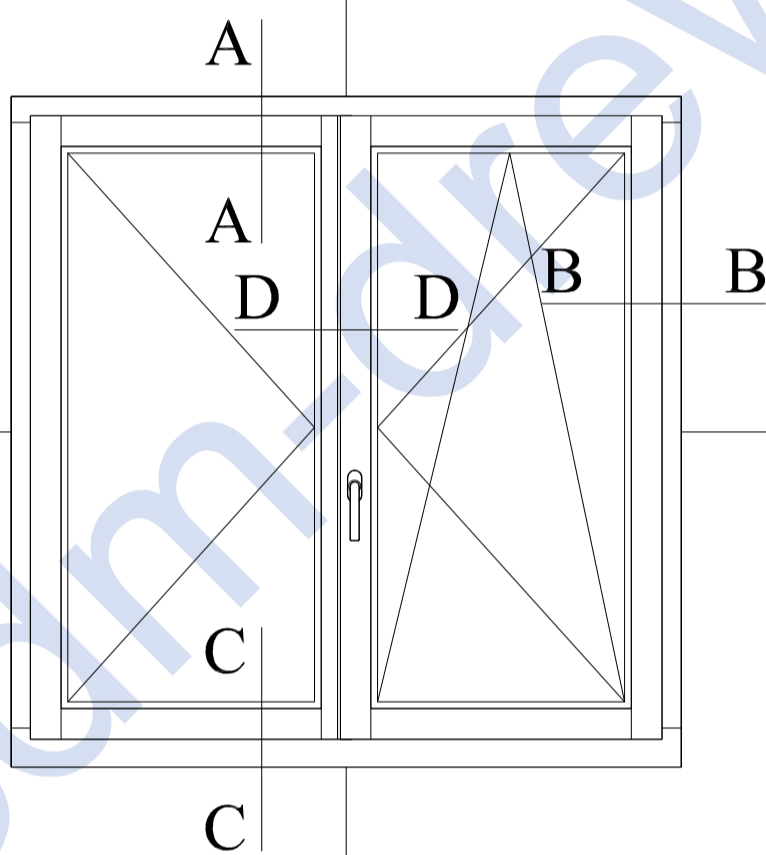
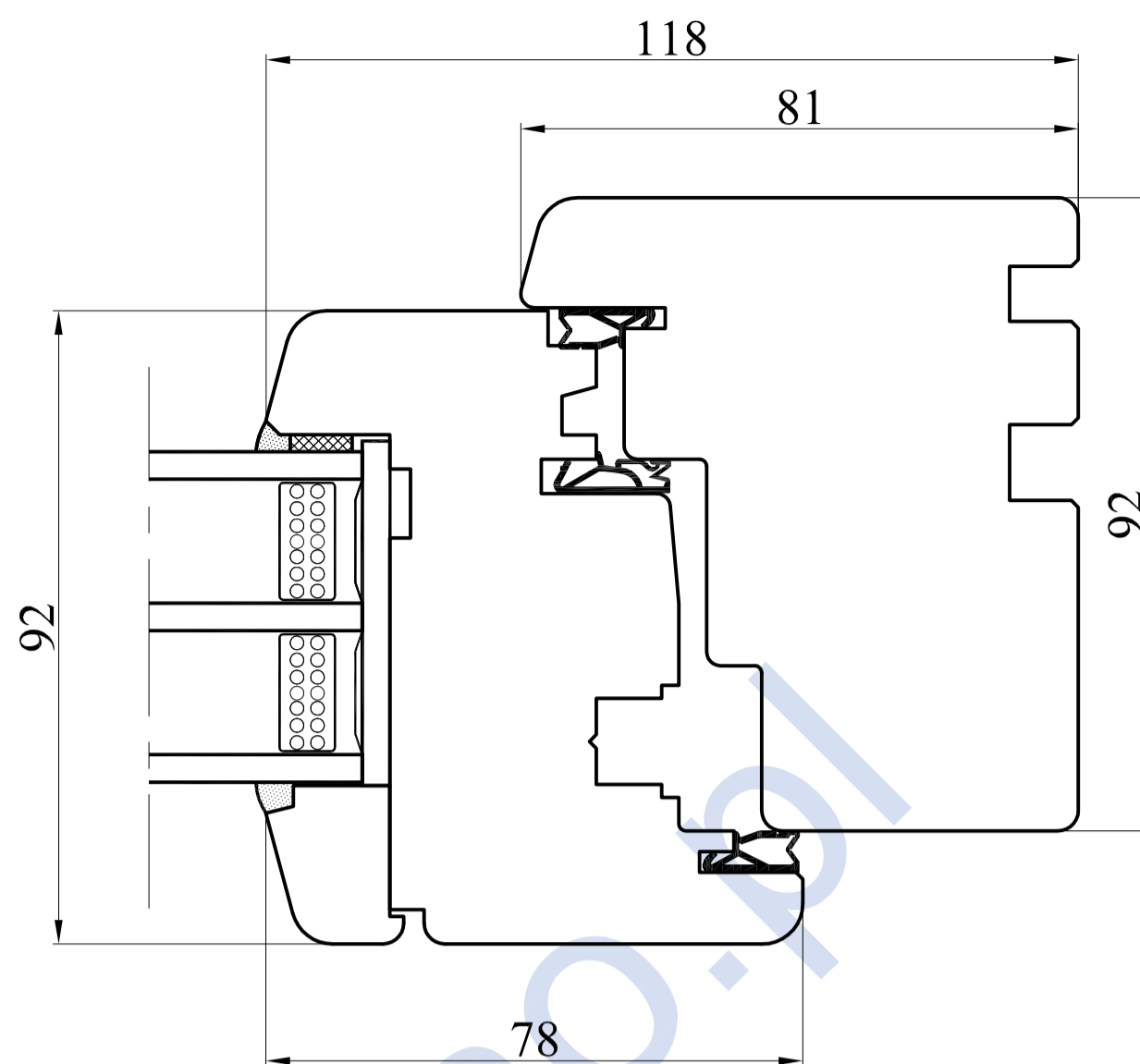

Przekrój C-C

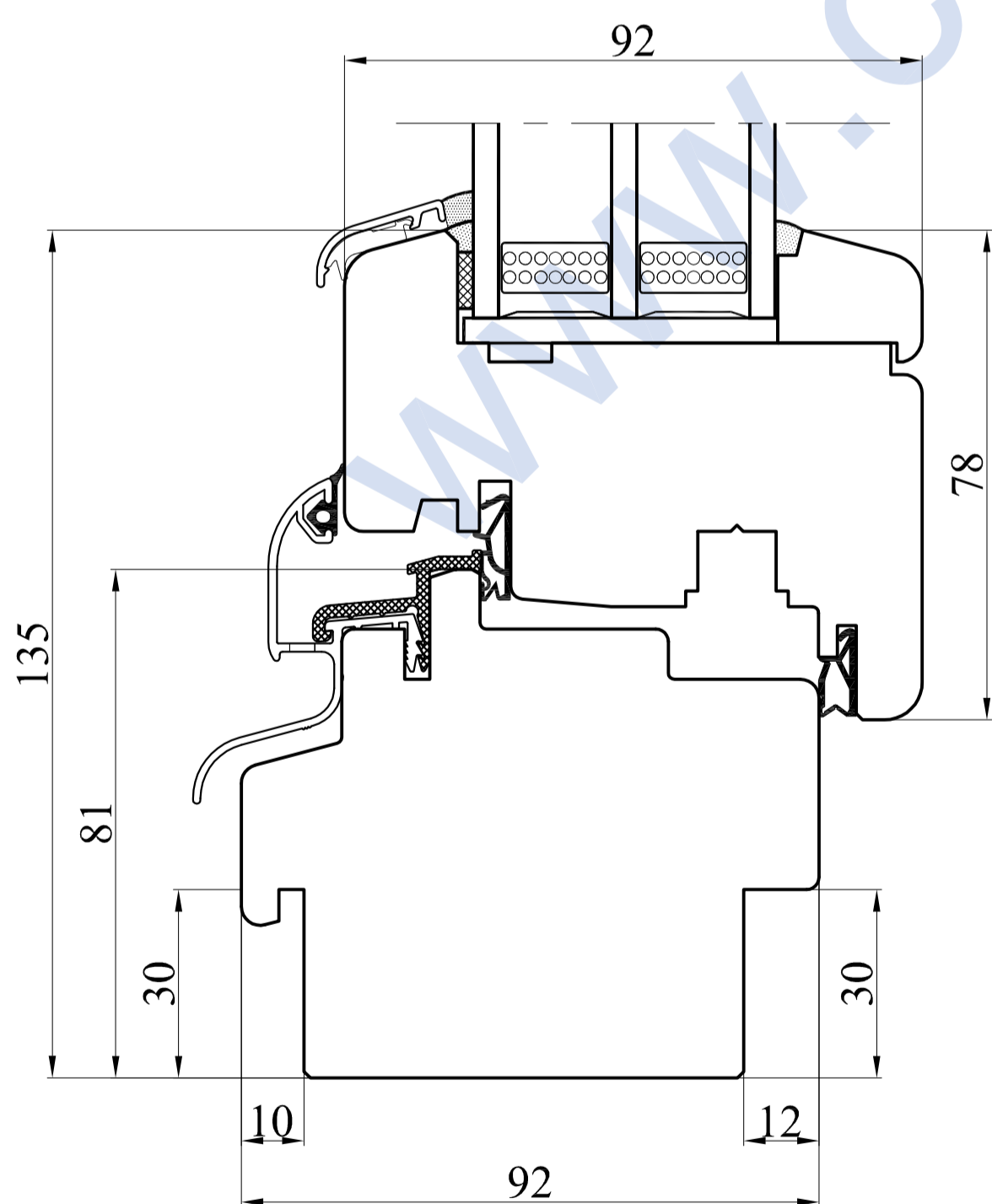

Przekrój D-D

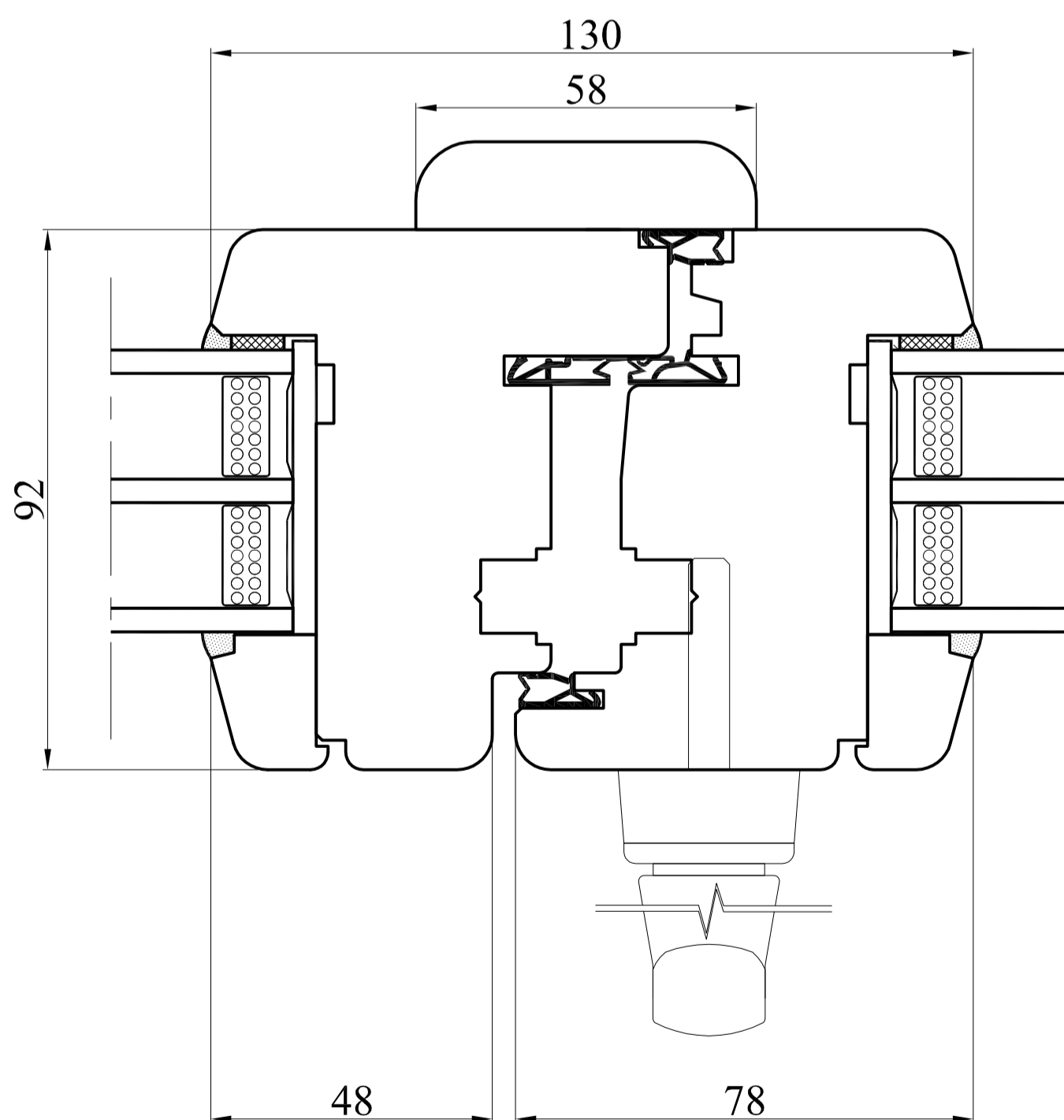

Typ	2-skrzydłowe słupek ruchomy	Data	01.10.2013
Profil	SOFT-LINE 92_3 uszczelki	Skala	1:1
Nr rys.	10/SL-92_3	Format	A2



**PRODUCENT OKIEN I DRZWI**

CDM Sp. z o.o.  
ul. Wojska Polskiego 112A, 16-400 Suwałki  
tel. + 48 87 565 36 45, fax + 48 87 565 36 68  
www.cdm-drewno.pl